	Datasheet	No.	DS10-U004
		Initial Date	2017-12-28
OU	OU8S3414	Written Team	R&D Dept.
			GH Zheng

I Preview

PN	OU8S3414
Description	100G QSFP28 ER4 1310nm-band 40KM LC DDMI 0~70 °C

II Contents

1. Features
2. Applications
3. Description
4. Absolute maximum Ratings
5. Operating Environment
6. Optical Characteristics
7. Electrical Specifications
8. Pin Descriptions
9. Diagnostic Monitoring Interface
10. Mechanical Dimensions
11. Model Ordering Information

III Revision History

No.	Date	Items	Change Recording	Ver.	Rev.	Customer
1	2017-12-28	All	Initial registration	000	000	Standard
2						
3						
4						
5						
6						

 Communication Limited	Datasheet		DS10-U004 Final Rev.: 2017-12-28	
	Product	100G QSFP28 transceiver OU serials	Ver.	000
	Part No.	OU8S3414	Rev.	000
			Page	2 / 14

1. Features

- ◆ Hot pluggable QSFP28 MSA form factor
- ◆ Compliant to Ethernet 100GBASE-ER4 Lite and OTN OTU4 4L1-9C1F Lite
- ◆ Up to 30km reach for G.652 SMF without FEC
- ◆ Up to 40km reach for G.652 SMF with FEC
- ◆ Single +3.3V power supply
- ◆ Transmitter: cooled 4x25.78125Gb/s LAN WDM EML TOSA (1295.56, 1300.05, 1304.58, 1309.14nm)
- ◆ Receiver: 4x25.78125Gb/s APD ROSA
- ◆ 4x25.78125G Electrical Serial Interface (CEI-28G-VSR)
- ◆ Maximum power consumption 4.5W
- ◆ Duplex LC receptacle
- ◆ RoHS-6 compliant
- ◆ Operating case temperature: 0~70°C

2. Applications

- ◆ 100GBASE-ER4 Ethernet Links
- ◆ Infiniband QDR and DDR interconnects
- ◆ 100G Telecom connections
- ◆ Other links

3. Description

The OCRECOM's OU8S3414 is a 100Gb/s transceiver module designed for optical communication applications compliant to Ethernet 100GBASE-ER4 Lite standard. The module converts 4 input channels of 25Gb/s electrical data to 4 channels of LAN WDM optical signals and then multiplexes them into a single channel for 100Gb/s optical transmission. Reversely on the receiver side, the module de-multiplexes a 100Gb/s optical input into 4 channels of LAN WDM optical signals and then converts them to 4 output channels of electrical data.

The central wavelengths of the 4 LAN WDM channels are 1295.56, 1300.05, 1304.58 and 1309.14 nm as members of the LAN WDM wavelength grid defined in IEEE 802.3ba. The high performance cooled LAN WDM EML transmitters and high sensitivity APD receivers provide superior performance for 100Gigabit Ethernet applications up to 30km links without FEC and 40km links with FEC.

The product is designed with form factor, optical/electrical connection and digital diagnostic interface according to the QSFP+ Multi-Source Agreement (MSA). It has been designed to meet the harshest external operating conditions including temperature, humidity and EMI interference.

The transceiver module receives 4 channels of 25Gb/s electrical data, which are processed by a 4-channel Clock and Data Recovery (CDR) IC that reshapes and reduces the jitter of each electrical signal. Subsequently, EML laser driver IC converts each one of the 4 channels of electrical signals to an optical signal that is transmitted from one of the 4 cooled EML lasers which are packaged in the Transmitter Optical Sub-Assembly (TOSA). Each laser launches the optical

OCRE COMMUNICATION LIMITED Web: www.ocrecom.com E-Mail: sales@ocrecom.com Add. Dist.A, Building 6, Bay on the six block, Xixiang, Baoan Dist, Shenzhen, China 518000 Tel: + 86 755 2335 3855 Fax: + 86 755 2335 3855	DESIGN	CHECK	CHECK	APPROVAL

 CRE Communication Limited	Datasheet		DS10-U004 Final Rev.: 2017-12-28	
	Product	100G QSFP28 transceiver OU serials	Ver.	000
	Part No.	OU8S3414	Rev.	000
			Page	3 / 14

signal in specific wavelength specified in IEEE 802.3ba 100GBASE-ER4 requirements. These 4-lane optical signals will be optically multiplexed into a single fiber by a 4-to-1 optical WDM MUX. The optical output power of each channel is maintained constant by an automatic power control (APC) circuit. The transmitter output can be turned off by TX_DIS hardware signal and/or 2-wire serial interface.

The receiver receives 4-lane LAN WDM optical signals. The optical signals are de-multiplexed by a 1-to-4 optical DEMUX and each of the resulting 4 channels of optical signals is fed into one of the 4 receivers that are packaged into the Receiver Optical Sub-Assembly (ROSA). Each receiver converts the optical signal to an electrical signal. The regenerated electrical signals are retimed and de-jittered and amplified by the RX portion of the 4-channel CDR. The retimed 4-lane output electrical signals are compliant with CEI-28G-VSR interface requirements. In addition, each received optical signal is monitored by the DOM section. The monitored value is reported through the 2-wire serial interface. If one or more received optical signal is weaker than the threshold level, RX_LOS hardware alarm will be triggered.

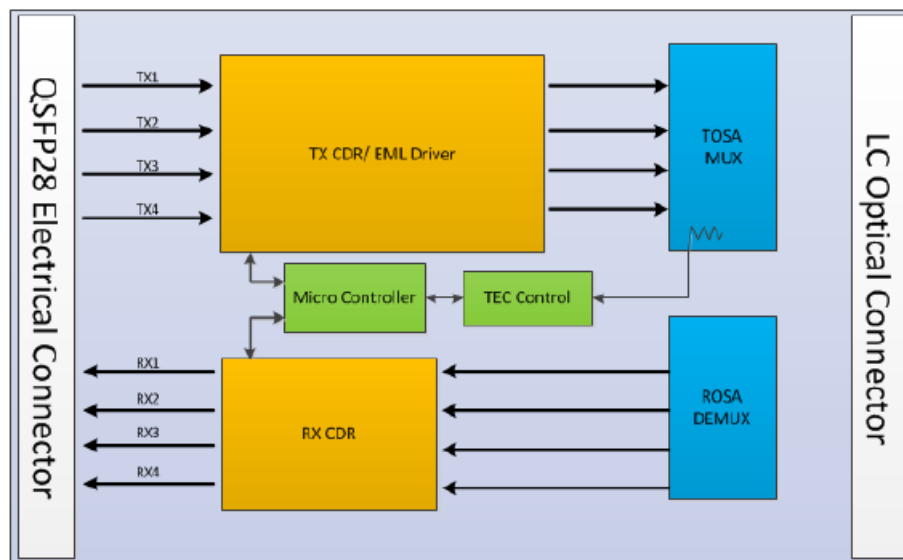

Figure 1 Block Diagram of transceiver

4. Absolute Maximum Ratings

The operation in excess of any absolute maximum ratings might cause permanent damage to this module.

Parameter	Symbol	Min	Max	Unit	Note
Storage Temperature	TST	-40	85	°C	
Relative Humidity(non-condensing)	RH	0	85	%	
Operating Case Temperature	TOPC	0	70	°C	
Supply Voltage	VCC	-0.3	3.6	V	
Damage Threshold, each Lane	TH _d	3.0		dBm	

5. Operating Environment

OCRE COMMUNICATION LIMITED Web: www.ocrecom.com E-Mail: sales@ocrecom.com Add. Dist.A, Building 6, Bay on the six block, Xixiang, Baoan Dist, Shenzhen, China 518000 Tel: + 86 755 2335 3855 Fax: + 86 755 2335 3855	DESIGN	CHECK	CHECK	APPROVAL

 Communication Limited	Datasheet		DS10-U004 Final Rev.: 2017-12-28	
	Product	100G QSFP28 transceiver OU serials	Ver.	000
	Part No.	OU8S3414	Rev.	000
			Page	4 / 14

Parameter	Symbol	Min	Typical	Max	Unit
Operating Case Temperature	TOPC	0		70	°C
Power Supply Voltage	VCC	3.13	3.3	3.47	V
Power Consumption		-		4.5	W
Data Rate	DR		25.78125		Gbps
Data Speed Tolerance	ΔDR	-100		+100	ppm
Control Input Voltage High		2		V _{cc}	V
Control Input Voltage Low		0		0.8	V
Link Distance with G.652 (without FEC)	D1			30	km
Link Distance with G.652 (with FEC)	D2			40	km

Please notice the transmit distance depending on actual fiber loss. Here specified by the fiber insertion loss is 0.4dB/KM

6. Optical Characteristics

All parameters are specified under the recommended operating conditions with PRBS31 data pattern unless otherwise specified.

Transmitter						
Parameter	Symbol	Min	Typical	Max	Unit	Notes
Wavelength Assignment	L0	1294.53	1295.56	1296.59	nm	
	L1	1299.02	1300.05	1301.09	nm	
	L2	1303.54	1304.58	1305.63	nm	
	L3	1308.09	1309.14	1310.19	nm	
Side Mode Suppression Ratio	SMSR	30			dB	
Total Average Launch Power	P _T	-	-	+10.5	dBm	
Average Launch Power, each Lane	PAVG	-2.9		4.5	dBm	1
Optical Modulation Amplitude (OMA)	POMA	0.1	-	+4.5	dBm	2
Difference in Launch Power between any two lanes	P _{tx,diff}			3.6	dB	
Launch Power in OMA minus Transmitter and Dispersion Penalty (TDP), each Lane		-0.65			dBm	
Transmitter and Dispersion Penalty per Lane	TDP			2.5	dBm	

OCRE COMMUNICATION LIMITED Web: www.ocrecom.com E-Mail: sales@ocrecom.com Add. Dist.A, Building 6, Bay on the six block, Xixiang, Baoan Dist, Shenzhen, China 518000 Tel: + 86 755 2335 3855 Fax: + 86 755 2335 3855	DESIGN	CHECK	CHECK	APPROVAL

 Communication Limited	Datasheet		DS10-U004 Final Rev.: 2017-12-28	
	Product	100G QSFP28 transceiver OU serials	Ver.	000
	Part No.	OU8S3414	Rev.	000
			Page	5 / 14

RIN ₂₀ OMA	RIN			-130	dB/Hz	
Extinction Ratio	ER	7			dB	
Transmitter Reflectance	R _T			-12	dB	
Optical Return Loss Tolerance	TOL			20	dB	
Average Launch Power OFF Transmitter, each Lane	P _{off}			-30	dBm	
Transmitter Eye Mask Definition {X1, X2, X3, Y1, Y2, Y3}		{0.25, 0.4, 0.45, 0.25, 0.28, 0.4}				
Receiver						
Wavelength Assignment	L0	1294.53	1295.56	1296.59	nm	
	L1	1299.02	1300.05	1301.09	nm	
	L2	1303.54	1304.58	1305.63	nm	
	L3	1308.09	1309.14	1310.19	nm	
Damage Threshold	THd	-3			dBm	3
Average Receive Power, each Lane		-16.9		-4.9	dBm	link of 30KM
Average Receive Power, each Lane		-20.9		-4.9	dBm	Link of 40KM
Receive Power OMA, each Lane				-1.9	dBm	
Receiver Sensitivity in OMA, each Lane	SEN			-14.65	dBm	BER = 1x10 ⁻¹²
Stressed Receiver Sensitivity (OMA), each Lane				-12.65	dBm	
Receiver Sensitivity in OMA, each Lane	SEN			-18.45	dBm	BER = 5x10 ⁻⁵
Stressed Receiver Sensitivity (OMA), each Lane				-16.65	dBm	
Difference in Receive Power between any two lanes OMA	P _{rx} , diff			3.6	dB	
Signal Loss Assert Threshold	LOSA	-	-26	-	dBm	
Signal Loss Deassert Threshold	LOSD	-	-24	-	dBm	
LOS Hysteresis	LOSH	0.5	-	-	dB	
Receiver Reflectance	R _R			-26	dBm	

OCRE COMMUNICATION LIMITED Web: www.ocrecom.com E-Mail: sales@ocrecom.com Add. Dist.A, Building 6, Bay on the six block, Xixiang, Baoan Dist, Shenzhen, China 518000 Tel: + 86 755 2335 3855 Fax: + 86 755 2335 3855	DESIGN	CHECK	CHECK	APPROVAL

 Communication Limited	Datasheet		DS10-U004 Final Rev.: 2017-12-28	
	Product	100G QSFP28 transceiver OU serials	Ver.	000
	Part No.	OU8S3414	Rev.	000
			Page	6 / 14

Receiver Electrical 3 dB upper Cutoff Frequency, each Lane	Fc			31	GHz	
Conditions of Stress Receiver Sensitivity Test						4
Vertical Eye Closure Penalty, each Lane			1.5		dB	
Stressed Eye J2 Jitter, each Lane			0.3		UI	
Stressed Eye J9 Jitter, each Lane			0.47		UI	

Notes:

1. The minimum average launch power spec is based on ER not exceeding 9.5dB and transmitter OMA higher than 0.1dBm.
2. Even if the TDP < 0.75 dB, the OMA min must exceed the minimum value specified here.
3. See Figure below.

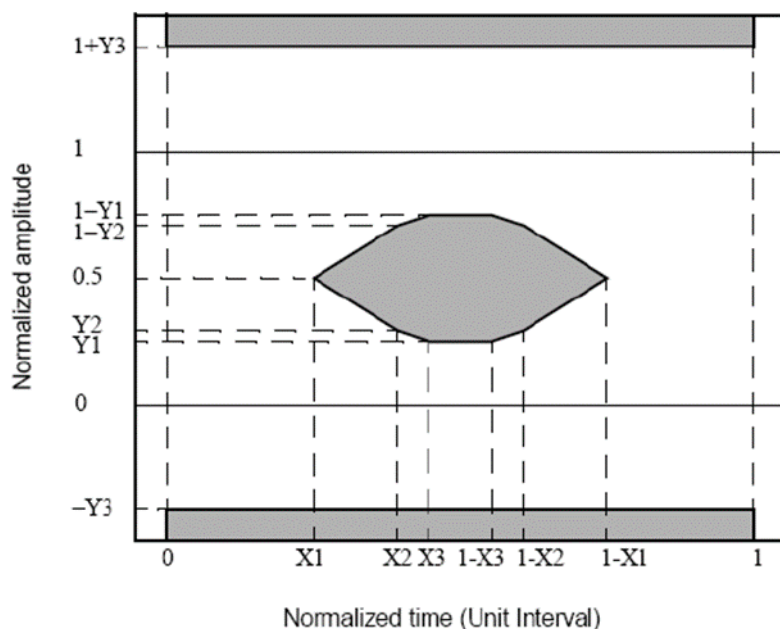

4. The receiver shall be able to tolerate, without damage, continuous exposure to a modulated optical input signal having this power level on one lane. The receiver does not have to operate correctly at this input power.

OCRE COMMUNICATION LIMITED Web: www.ocrecom.com E-Mail: sales@ocrecom.com Add. Dist.A, Building 6, Bay on the six block, Xixiang, Baoan Dist, Shenzhen, China 518000 Tel: + 86 755 2335 3855 Fax: + 86 755 2335 3855	DESIGN	CHECK	CHECK	APPROVAL

 Communication Limited	Datasheet		DS10-U004 Final Rev.: 2017-12-28	
	Product	100G QSFP28 transceiver OU serials	Ver.	000
	Part No.	OU8S3414	Rev.	000
			Page	7 / 14

7. Electrical Specifications

Parameter	Test Point	Min	Typical	Max	Units	Notes
Power Consumption				4.5	W	
Supply Current	Icc			1.36	A	
Transmitter (each Lane)						
Overload Differential Voltage pk-pk	TP1a	900			mV	
Common Mode Voltage (Vcm)	TP1	-350		2850	mV	1
Differential Termination Resistance Mismatch	TP1			10	%	At 1MHz
Differential Return Loss (SDD11)	TP1			See CEI-28G-VSR Equation 13-19	dB	
Common Mode to Differential conversion and Differential to Common Mode conversion (SDC11, SCD11)	TP1			See CEI-28G-VSR Equation 13-20	dB	
Stressed Input Test	TP1a	See CEI-28G-VSR Section 13.3.11.2.1				
Receiver (each Lane)						
Differential Voltage, pk-pk	TP4			900	mV	
Common Mode Voltage (Vcm)	TP4	-350		2850	mV	1
Common Mode Noise, RMS	TP4			17.5	mV	
Differential Termination Resistance Mismatch	TP4			10	%	At 1MHz
Differential Return Loss (SDD22)	TP4			See CEI-28G-VSR Equation 13-19	dB	
Common Mode to Differential	TP4			See CEI-	dB	
OCRE COMMUNICATION LIMITED Web: www.ocrecom.com E-Mail: sales@ocrecom.com Add. Dist.A, Building 6, Bay on the six block, Xixiang, Baoan Dist, Shenzhen, China 518000 Tel: + 86 755 2335 3855 Fax: + 86 755 2335 3855		DESIGN	CHECK	CHECK	APPROVAL	

 Communication Limited	Datasheet		DS10-U004 Final Rev.: 2017-12-28	
	Product	100G QSFP28 transceiver OU serials	Ver.	000
	Part No.	OU8S3414	Rev.	000
			Page	8 / 14

conversion and Differential to Common Mode conversion (SDC22,SCD22)				28G-VSR Equation 13-21		
Common Mode Return Loss (SCC22)	TP4			-2	dB	2
Transition Time, 20 to 80%	TP4	9.5			ps	
Vertical Eye Closure (VEC)	TP4			5.5	dB	
Eye Width at 10 ⁻¹⁵ probability (EW15)	TP4	0.57			UI	
Eye Height at 10 ⁻¹⁵ probability (EH15)	TP4	228			mV	

Notes:

1. Vcm is generated by the host. Specification includes effects of ground offset voltage.
2. From 250MHz to 30GHz.

8. Pin Descriptions

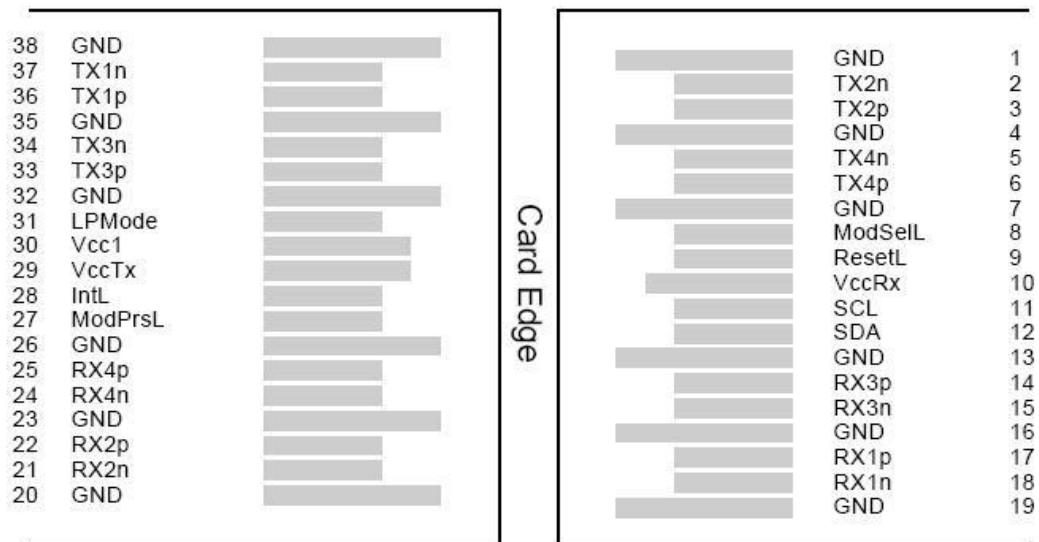

Top Side
Viewed from Top

Bottom Side
Viewed from Bottom

PIN	Logic	Symbol	Name/Description	Note
1		GND	Ground	1
2	CML-I	Tx2n	Transmitter Inverted Data Input	

OCRE COMMUNICATION LIMITED Web: www.ocrecom.com E-Mail: sales@ocrecom.com Add. Dist.A, Building 6, Bay on the six block, Xixiang, Baoan Dist, Shenzhen, China 518000 Tel: + 86 755 2335 3855 Fax: + 86 755 2335 3855	DESIGN	CHECK	CHECK	APPROVAL



Communication Limited

Datasheet

DS10-U004
Final Rev.: 2017-12-28

Product 100G QSFP28 transceiver
OU serials

Ver. 000

Part No. OU8S3414

Rev. 000

Page 9 / 14

3	CML-I		Tx2p	Transmitter Non-Inverted Data output	
4			GND	Ground	1
5	CML-I		Tx4n	Transmitter Inverted Data Input	
6	CML-I		Tx4p	Transmitter Non-Inverted Data output	
7			GND	Ground	1
8	LVTTL-I		ModSelL	Module Select	
9	LVTTL-I		ResetL	Module Reset	
10			VccRx	+ 3.3V Power Supply Receiver	2
11	LVC MOS-I/O		SCL	2-Wire Serial Interface Clock	
12	LVC MOS-I/O		SDA	2-Wire Serial Interface Data	
13			GND	Ground	
14	CML-O		Rx3p	Receiver Non-Inverted Data Output	
15	CML-O		Rx3n	Receiver Inverted Data Output	
16			GND	Ground	1
17	CML-O		Rx1p	Receiver Non-Inverted Data Output	
18	CML-O		Rx1n	Receiver Inverted Data Output	
19			GND	Ground	1
20			GND	Ground	1
21	CML-O		Rx2n	Receiver Inverted Data Output	
22	CML-O		Rx2p	Receiver Non-Inverted Data Output	
23			GND	Ground	1
24	CML-O		Rx4n	Receiver Inverted Data Output	1
25	CML-O		Rx4p	Receiver Non-Inverted Data Output	
26			GND	Ground	1
27	LVTTL-O		ModPrsL	Module Present	
28	LVTTL-O		IntL	Interrupt	
29			VccTx	+3.3 V Power Supply transmitter	2
30			Vcc1	+3.3 V Power Supply	2
31	LVTTL-I		LPMODE	Low Power Mode	
32			GND	Ground	1
33	CML-I		Tx3p	Transmitter Non-Inverted Data Input	
34	CML-I		Tx3n	Transmitter Inverted Data Output	
35			GND	Ground	1

OCRE COMMUNICATION LIMITED Web: www.ocrecom.com E-Mail: sales@ocrecom.com Add. Dist.A, Building 6, Bay on the six block, Xixiang, Baoan Dist, Shenzhen, China 518000 Tel: + 86 755 2335 3855 Fax: + 86 755 2335 3855	DESIGN	CHECK	CHECK	APPROVAL

 CRE Communication Limited	Datasheet		DS10-U004 Final Rev.: 2017-12-28	
	Product	100G QSFP28 transceiver OU serials	Ver.	000
	Part No.	OU8S3414	Rev.	000
			Page	10 / 14

36	CML-I	TxIp	Transmitter Non-Inverted Data Input	
37	CML-I	TxIn	Transmitter Inverted Data Output	
38		GND	Ground	1

Notes:

1. GND is the symbol for signal and supply (power) common for the QSFP28 module. All are common within the module and all module voltages are referenced to this potential unless otherwise noted. Connect these directly to the host board signal common ground plane.

2. VccRx, VccI and VccTx are the receiving and transmission power suppliers and shall be applied concurrently. Recommended host board power supply filtering is shown in Figure 2 below. Vcc Rx, VccI and Vcc Tx may be internally connected within the module in any combination. The connector pins are each rated for a maximum current of 1000mA.

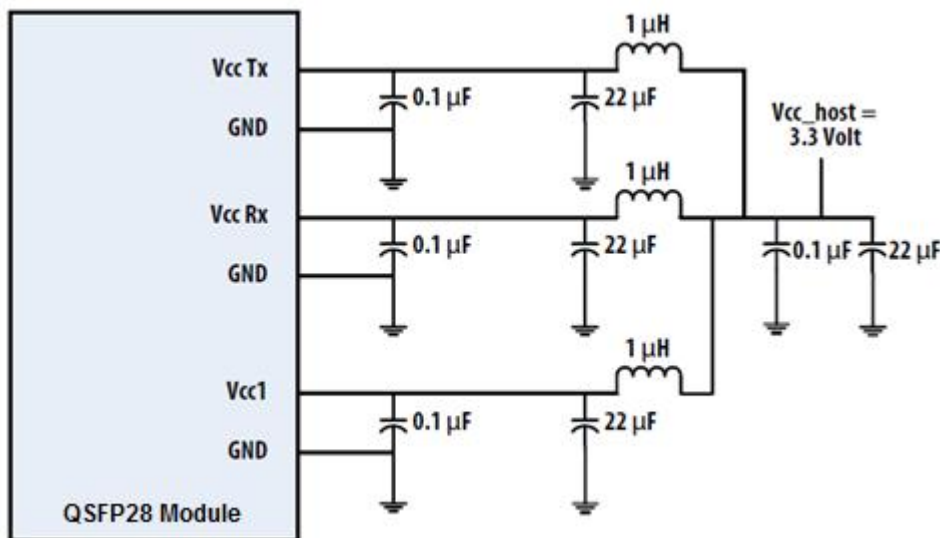

Figure 2 Power supply Filter

ModSelL Pin

The ModSelL is an input pin. When held low by the host, the module responds to 2-wire serial communication commands. The ModSelL allows the use of multiple QSFP modules on a single 2-wire interface bus. When the ModSelL is “High”, the module will not respond to any 2-wire interface communication from the host. ModSelL has an internal pull-up in the module.

ResetL Pin

Reset. LPMoDe_ Reset has an internal pull-up in the module. A low level on the ResetL pin for longer than the minimum pulse length (t_{Reset_init}) initiates a complete module reset, returning all user module settings to their default state. Module Reset Assert Time (t_{init}) starts on the rising edge after the low level on the ResetL pin is released. During the execution of a reset (t_{init}) the host shall disregard all status bits until the module indicates a completion of the reset

OCRE COMMUNICATION LIMITED Web: www.ocrecom.com E-Mail: sales@ocrecom.com Add. Dist.A, Building 6, Bay on the six block, Xixiang, Baoan Dist, Shenzhen, China 518000 Tel: + 86 755 2335 3855 Fax: + 86 755 2335 3855	DESIGN	CHECK	CHECK	APPROVAL

 Communication Limited	Datasheet		DS10-U004 Final Rev.: 2017-12-28	
	Product	100G QSFP28 transceiver OU serials	Ver.	000
	Part No.	OU8S3414	Rev.	000
			Page	11 / 14

interrupt. The module indicates this by posting an IntL signal with the Data_Not_Ready bit negated. Note that on power up (including hot insertion) the module will post this completion of reset interrupt without requiring a reset.

LPMode Pin

OCRECOM's OU8S3414 QSFP28 ER4 operate in the low power mode (less than 1.5 W power consumption) This pin active high will decrease power consumption to less than 1W.

ModPrsL Pin

ModPrsL is pulled up to Vcc on the host board and grounded in the module. The ModPrsL is asserted "Low" when the module is inserted and deasserted "High" when the module is physically absent from the host connector.

IntL Pin

IntL is an output pin. When "Low", it indicates a possible module operational fault or a status critical to the host system. The host identifies the source of the interrupt by using the 2-wire serial interface. The IntL pin is an open collector output and must be pulled up to Vcc on the host board.

9. Diagnostic Monitoring Interface

Digital diagnostics monitoring function is available on all OCRECOM's OU8S3414 QSFP28 ER4. A 2-wire serial interface provides user to contact with module. The structure of the memory is shown in the chart. The memory space is arranged into a lower, single page, address space of 128 bytes and multiple upper address space pages. This structure permits timely access to addresses in the lower page, such as Interrupt Flags and Monitors. Less time critical time entries, such as serial ID information and threshold settings, are available with the Page Select function. The interface address used is A0xh and is mainly used for time critical data like interrupt handling in order to enable a one-time-read for all data related to an interrupt situation. After an interrupt, IntL, has been asserted, the host can read out the flag field to determine the affected channel and type of flag.

Address	Size (Bytes)	Name	Description of Base ID Field	Optical Module
128	1	Identifier	Identifier Type of serial Module	
129	1	Ext. Identifier	Extended Identifier of Serial Module	
130	1	Connector	Code for connector type	
131-138	8	Specification compliance	Code for electronic compatibility or optical compatibility	
139	1	Encoding	Code for serial encoding algorithm	
140	1	BR, nominal	Nominal bit rate, units of 100 Mbits/s	

OCRE COMMUNICATION LIMITED Web: www.ocrecom.com E-Mail: sales@ocrecom.com Add. Dist.A, Building 6, Bay on the six block, Xixiang, Baoan Dist, Shenzhen, China 518000 Tel: + 86 755 2335 3855 Fax: + 86 755 2335 3855	DESIGN	CHECK	CHECK	APPROVAL

 Communication Limited	Datasheet		DS10-U004 Final Rev.: 2017-12-28	
	Product	100G QSFP28 transceiver OU serials	Ver.	000
	Part No.	OU8S3414	Rev.	000
			Page	12 / 14

141	1	Extended rateselect Compliance	Tags for extended rate select compliance	
142	1	Length(SMF)	Link length supported for SMF fiber in km (note 1)	
143	1	Length(OM3 50 um)	Link length supported for EBW 50/125 um fiber (OM3), units of 2m (note 1)	
144	1	Length(OM2 50 um)	Link length supported for 50/125 um fiber (OM2), units of 1m (note 1)	
145	1	Length(OM1 62.5 um)	Link length supported for 62.5/125 um fiber (OM1), units of 1m (note 1)	
146	1	Length (Copper)	Link length of copper or active cable, units of 1 m (note 1)Link length supported for 50/125 um fiber (OM4), units of 2 m) when Byte 147 declares 850nm VCSEL as defined inTable 37	
147	1	Device tech	Device technology	
148-163	16	Vendor name	QSFP28 vendor name(ASCII)	
164	1	Extended Module	Extended Module codes for InfiniBand	
165-167	3	Vendor OUI	QSFP28 vendor IEEE company ID	
168-183	16	Vendor PN	Part number provided by QSFP28 vendor(ASCII)	
184-185	2	Vendor rev	Revision level for part number provided by vendor(ASCII)	
186-187	2	Wave length or Copper cable Attenuation	Nominal laser wavelength (wavelength=value/20 in nm) or copper cable attenuation in dB at 2.5GH (Adrs 186) and 5.0GHz (Adrs 187)	
188-189	2	Wavelength tolerance	Guaranteed range of laser wavelength(+/- value) from nominal wavelength.(wavelength Tol.=value/200 in nm)	
190	1	Max case temp.	Maximum case temperature in degrees C	
191	1	CC_BASE	Check code for base ID fields (addresses 128-190)	

OCRE COMMUNICATION LIMITED Web: www.ocrecom.com E-Mail: sales@ocrecom.com Add. Dist.A, Building 6, Bay on the six block, Xixiang, Baoan Dist, Shenzhen, China 518000 Tel: + 86 755 2335 3855 Fax: + 86 755 2335 3855	DESIGN	CHECK	CHECK	APPROVAL

 Communication Limited	Datasheet		DS10-U004 Final Rev.: 2017-12-28	
	Product	100G QSFP28 transceiver OU serials	Ver.	000
	Part No.	OU8S3414	Rev.	000
			Page	13 / 14

192	1	Link Code	Extended specification compliance codes	
193-195	4	Options	Rate Select, TX Disable, TX Fault, LOS, Warning indicators for: Temperature, VCC, RX, power, TX Bias	
196-211	16	Vendor SN	Serial number provided by vendor (ASCII)	
212-219	8	Date Code	Vendor's manufacturing date code	
220	1	Diagnostic Monitoring Type	Indicates which types of diagnostic monitoring are implemented (if any) in the Module. Bit 1,0 Reserved	
221	1	Enhanced Options	Indicates which optional enhanced features are implemented in the Module.	
222	1	Baud Rate, Nominal	Nominal baud rate per channel, units of 250Mbd, Complements Byte 140.	
223	1	CC_EXT	Check code for the Extended ID Fields (addresses 192-222)	
Vendor Specific ID Fields				
224-255	32	Vendor Specific	Vendor Specific EEPROM	

Digital Diagnostic Functions

The following digital diagnostic characteristics are defined over the Recommended Operating Environment unless otherwise specified. It is compliant to SFF-8436.

Parameter	Symbol	Min	Max	Unit	Notes
Temperature monitor absolute error	DMI_Temp	-3	+3	degC	Over operating temp
Supply voltage monitor absolute error	DMI_VCC	-0.1	0.1	V	Full operating range
Channel RX power monitor absolute error	DMI_RX	-3	3	dB	Per channel
Channel Bias current monitor	DMI_Ibias	-10%	10%	mA	Per channel
Channel TX power monitor absolute error	DMI_TX	-3	3	dB	Per channel

OCRE COMMUNICATION LIMITED Web: www.ocrecom.com E-Mail: sales@ocrecom.com Add. Dist.A, Building 6, Bay on the six block, Xixiang, Baoan Dist, Shenzhen, China 518000 Tel: + 86 755 2335 3855 Fax: + 86 755 2335 3855	DESIGN	CHECK	CHECK	APPROVAL

 CRE Communication Limited	Datasheet		DS10-U004 Final Rev.: 2017-12-28	
	Product	100G QSFP28 transceiver OU serials	Ver.	000
	Part No.	OU8S3414	Rev.	000
			Page	14 / 14

10. Mechanical Dimensions

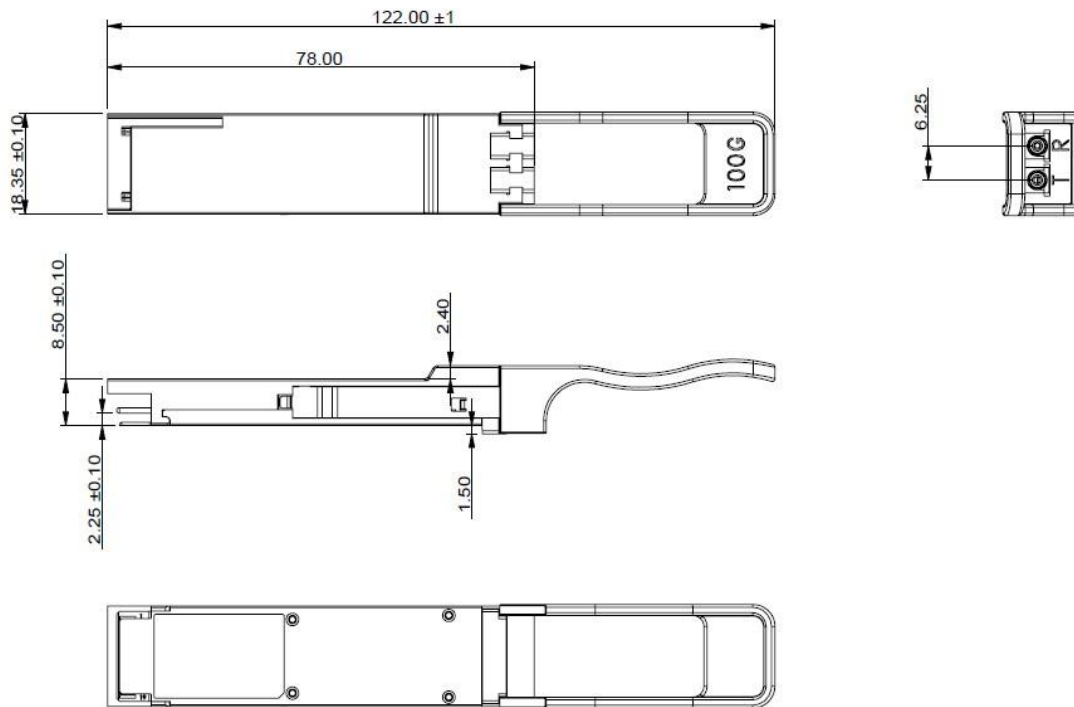

ESD

This transceiver is specified as ESD threshold 1KV for high speed data pins and 2KV for all others electrical input pins, tested per MIL-STD-883, Method 3015.4 /JESD22-A114-A (HBM). However, normal ESD precautions are still required during the handling of this module. This transceiver is shipped in ESD protective packaging. It should be removed from the packaging and handled only in an ESD protected environment.

Laser Safety

This is a Class 1 Laser Product according to IEC 60825-1:2007. This product complies with 21 CFR 1040.10 and 1040.11 except for deviations pursuant to Laser Notice No. 50, dated (June 24, 2007)

11. Module Ordering information

PN	Description
OU8S3414	100G QSFP28 ER4 1310nm-band 40KM LC DDMI 0~70 °C

OCRE COMMUNICATION LIMITED Web: www.ocrecom.com E-Mail: sales@ocrecom.com Add. Dist.A, Building 6, Bay on the six block, Xixiang, Baoan Dist, Shenzhen, China 518000 Tel: + 86 755 2335 3855 Fax: + 86 755 2335 3855	DESIGN	CHECK	CHECK	APPROVAL